

F

E

D

C

B

A

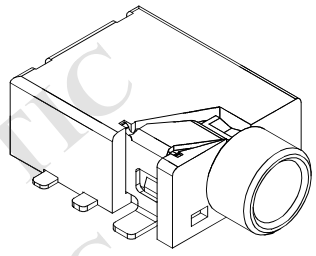

RoHS
Compliant

ZONE	SYMBOL	REVISION	APPROVAL	DATE

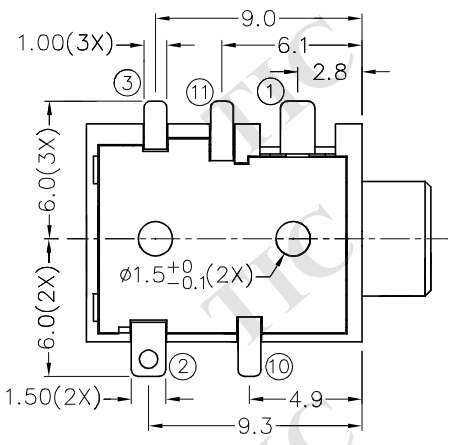
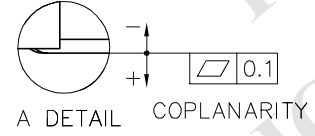
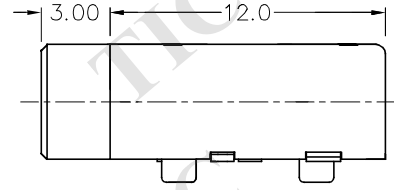
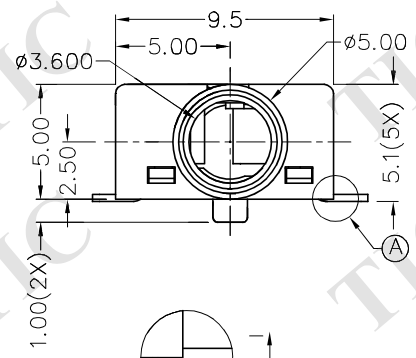
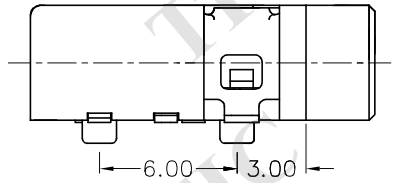

*MATERIAL
 TERMINAL 1 : COPPER ALLOY
 TERMINAL 2 : COPPER ALLOY
 TERMINAL 3 : COPPER ALLOY
 TERMINAL 10 : BRASS
 TERMINAL 11 : BRASS
 HOUSING : HIGH TEMP. PLASTIC
 COVER : HIGH TEMP. PLASTIC

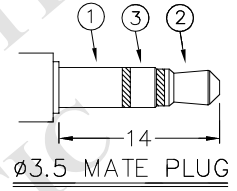
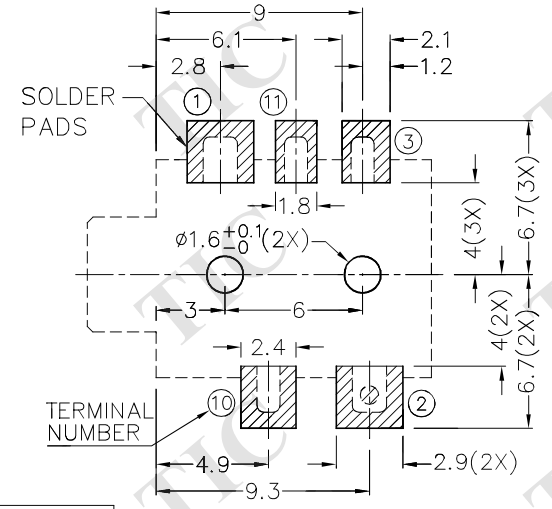

MODEL NO.	TSH-3675D	TSH-3674AD	TSH-3674BD	TSH-3673D	TSH-3673AD
SCHEMATIC					

RECOMMENDED PCB LAYOUT
 TOLERANCE: ±0.05
 (TOP VIEW)



TECHNIK INDUSTRIAL CO. LTD.

DESIGN	J.JIANG	DATE	3-5-2004	SCALE	3:1
DRAWING	Y.J.GUO	DATE	16-12-2016	MATERIAL	*
CHECK	T.Y.LI	DATE	16-12-2016	DWG. NO.	TZ\SH367D-A/1.0
APPROVAL		DATE		SHEET	

PART NAME	3.5mm SMD STEREO JACK	TOLERANCE UNLESS	0.0±0.2	UNIT:	mm
PART NO.	TSH-367D	OTHERWISE SPECIFIED:	0.00±0.1 0.000±0.05		

F

E

D

C

B

A