

F

E

D

C

B

A

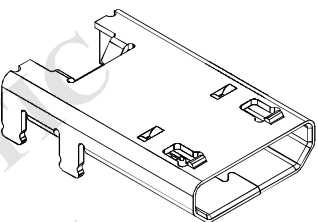

RoHS
Compliant

ZONE	SYMBOL	REVISION	APPROVAL	DATE
D2	⚠	ADD DIMENSION	J.X.KUANG	29-1-2019

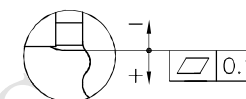
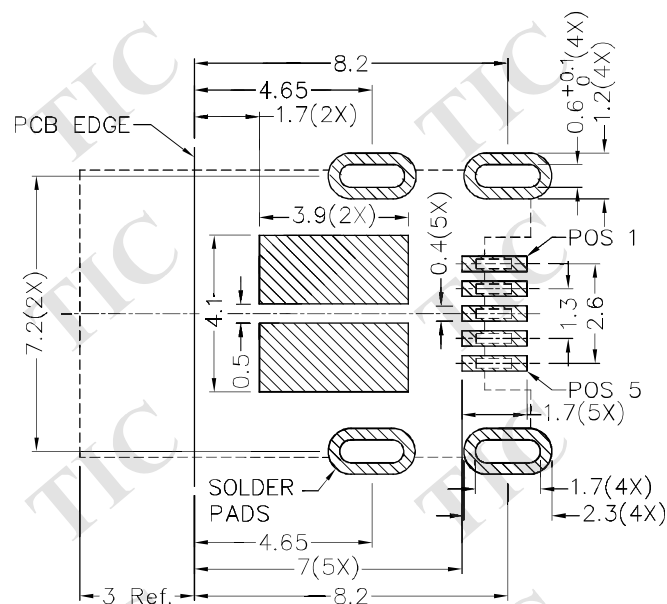
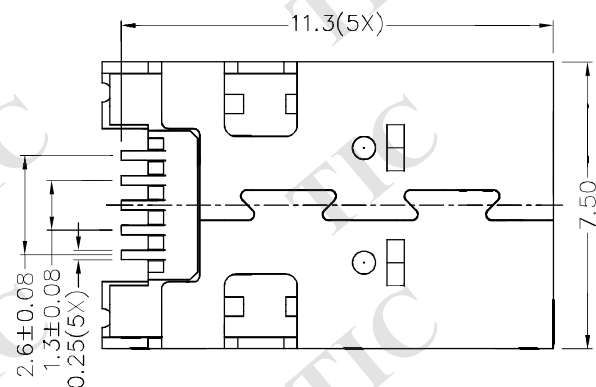
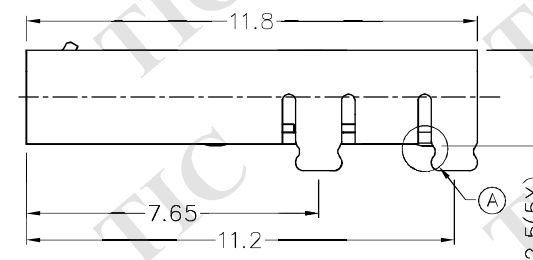
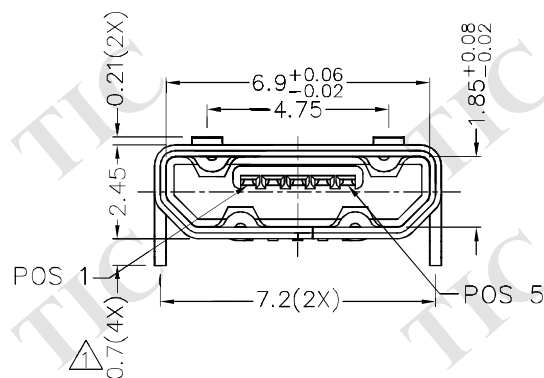
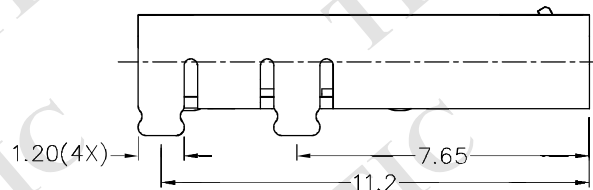

A DETAIL COPLANARITY

RECOMMENDED PCB LAYOUT
TOLERANCE: ± 0.05
(TOP VIEW)

DESCRIPTION	MATERIAL	PLATING
TERMINALS	COPPER ALLOY	NICKEL PLATED ON ALL AREA, GOLD FLASH ON CONTACT & SOLDER AREA
SHELL	STAINLESS STEEL	Ni: 50u" Min.
PLASTIC	HIGH TEMP. PLASTIC	COLOR: BLACK



TECHNIK INDUSTRIAL CO. LTD.

DESIGN	H.L.TAN	DATE	7-7-2015	SCALE	5:1
DRAWING	H.Q.ZHOU	DATE	29-1-2019	MATERIAL	
CHECK	T.Y.LI	DATE	29-1-2019	DWG. NO.	TZ\UB003D-A/1.2
APPROVAL		DATE		SHEET	

PART NAME MICRO USB B TYPE CONNECTOR

TOLERANCE UNLESS
0.0±0.2
0.00±0.1
OTHERWISE SPECIFIED: 0.000±0.05

UNIT:



PART NO. TUB-003D

F

E

D

C

B

A