

F

E

D

C

B

A

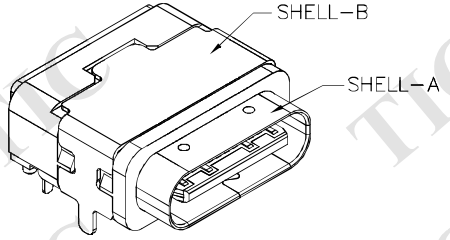

ZONE	SYMBOL	REVISION	APPROVAL	DATE

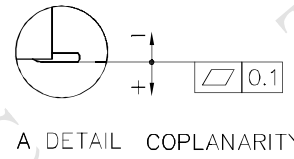
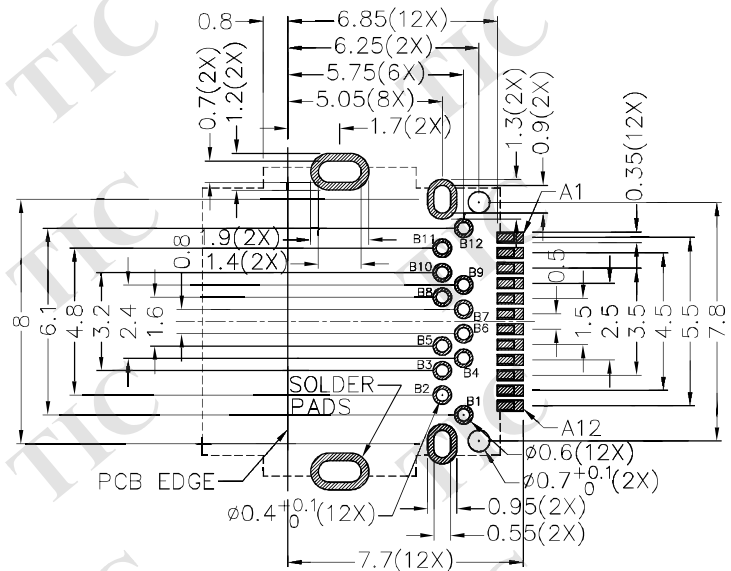
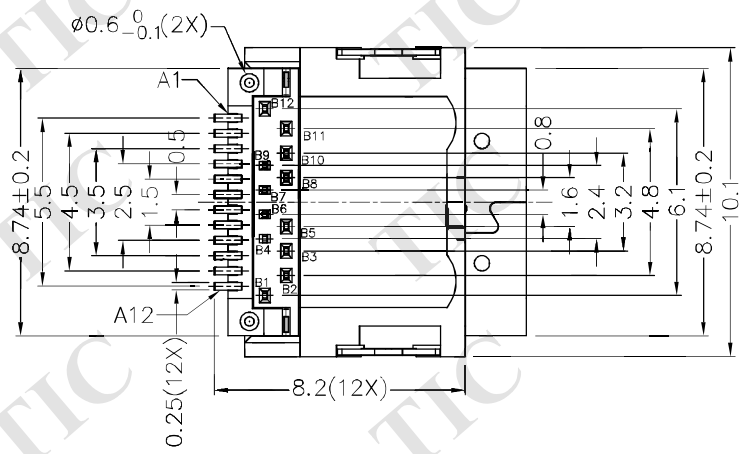
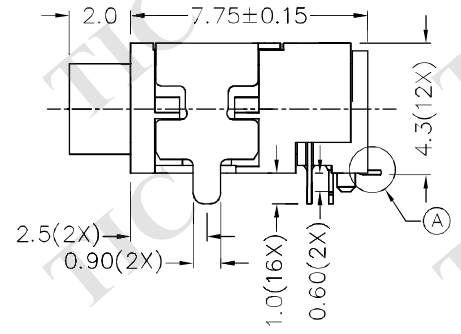
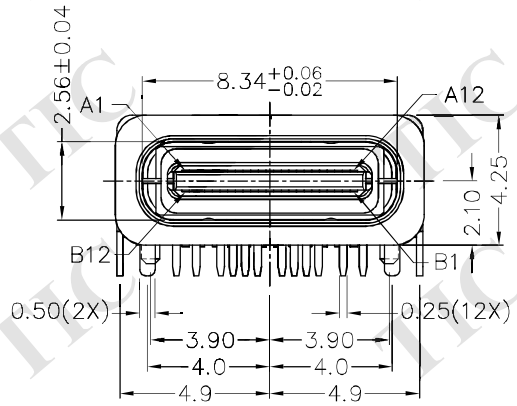
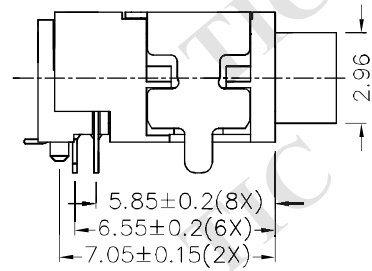

PIN NO.	A1	A2	A3	A4	A5	A6	A7	A8	A9	A10	A11	A12
	GND	TX1+	TX1-	VBUS	CC1	D+	D-	SBU1	VBUS	RX2-	RX2+	GND
PIN NO.	B12	B11	B10	B9	B8	B7	B6	B5	B4	B3	B2	B1
	GND	RX1+	RX1-	VBUS	SBU2	D-	D+	CC2	VBUS	TX2-	TX2+	GND

RECOMMENDED PCB LAYOUT
TOLERANCE: ±0.05
(TOP VIEW)

DESCRIPTION	MATERIAL	PLATING
CONTACT	COPPER ALLOY	NICKEL(Ni) ON ALL AREA, GOLD FLASH ON CONTACT AND SOLDER AREA
SHELL-A	STAINLESS STEEL	NICKEL(Ni)
SHELL-B	BRASS	NICKEL(Ni)
INNER GROUND COVER SHELL	STAINLESS STEEL	
MIDDLE PLATE	STAINLESS STEEL	NICKEL(Ni)
INSULATOR	HIGH TEMP. PLASTIC	COLOR: BLACK
HOUSING	HIGH TEMP. PLASTIC	COLOR: BLACK

TIC TECHNIK INDUSTRIAL CO. LTD.

DESIGN	H.L.TAN	DATE	30-11-2018	SCALE	4:1
DRAWING	H.Q.ZHOU	DATE	1-7-2019	MATERIAL	
CHECK	T.Y.LI	DATE	1-7-2019	DWG. NO.	TZ\WPC001D-A/1.0
APPROVAL		DATE		SHEET	1/1

PART NAME	WATERPROOF/DUSTPROOF USB 3.1 TYPE-C CONNECTOR	TOLERANCE UNLESS	0.0±0.2	UNIT:	mm
PART NO.	TWP-C001D	OTHERWISE SPECIFIED:	0.00±0.1 0.000±0.05		

F

E

D

C

B

A